

BELFAST

BOX DE DUCHA

Gorena

Guía de Instalación



CUIDADOS EN LA INSTALACION Y USO DEL PRODUCTO

- Gracias por elegir nuestro Box de Ducha
- Asegurar su normal uso, prolongará la vida de su producto.
- Lea atentamente las instrucciones de instalación y emplee personal calificado para dicha tarea.

Índice

1_ Herramientas necesarias	3
2_ Piezas y accesorios incluidos	4
3_ Procedimiento de instalación	5-10

Nota: En Gorena nos dedicamos a mejorar nuestros productos día a día. Esto podría hacer que alguna pieza haya sido reemplazada por una superior y diferir esta guía de su modelo actual.

Le pedimos disculpas por cualquier inconveniente de este tipo.

El modelo puede variar algunos elementos según perfilería (CROMO, NEGRA).











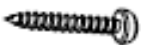









Herramientas necesarias (no incluidas)

Nombre	Herramienta
Nivel	
Cinta Métrica	
Llave francesa	
Destornillador phillips	
Tijera	
Silicona	
Taladro	
Mechas 3 mm	
Mechas 6 mm	
Marcador	

Piezas y Accesorios incluidos

1		ST4X30MM	X7
2		Φ6x30MM	X9
3		ST4X20MM	X2
4		M6x25MM	X1
5		Φ38MM	X2
6		Φ29MM	X2
7		40*17MM	X1
8		M6x25MM	X1
9			X2
10			X2
11			X2
12			X2
13			X2
14			X2
15			X2
16			X1





Procedimiento de instalación

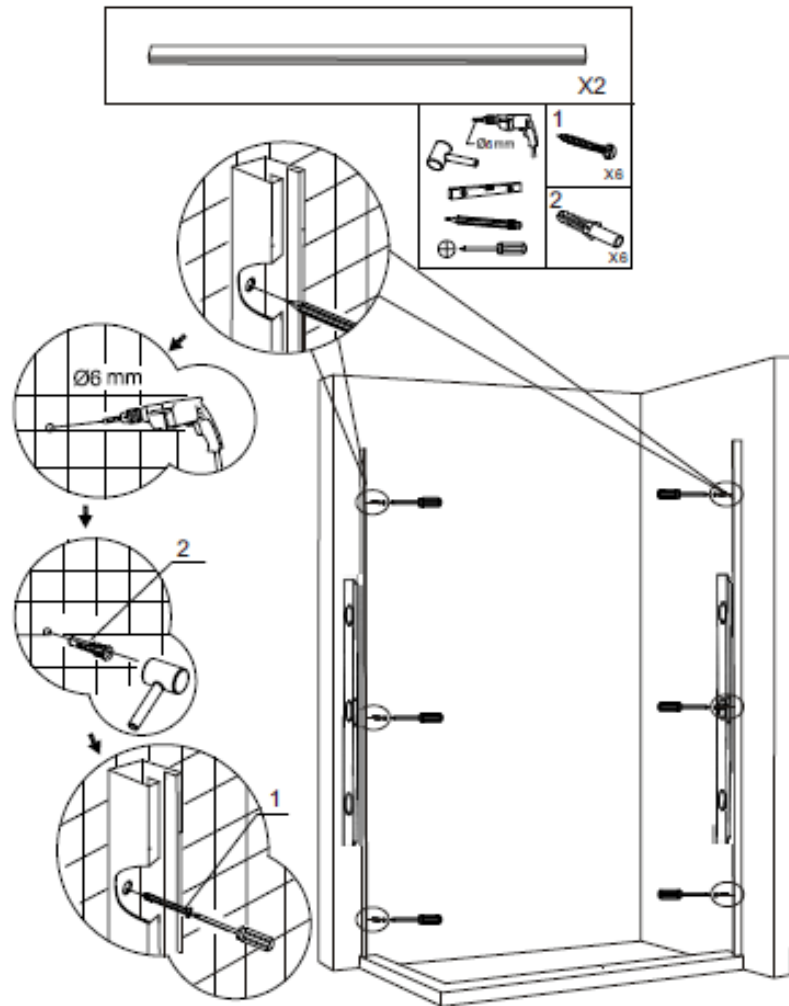

5

Procedimiento de instalación

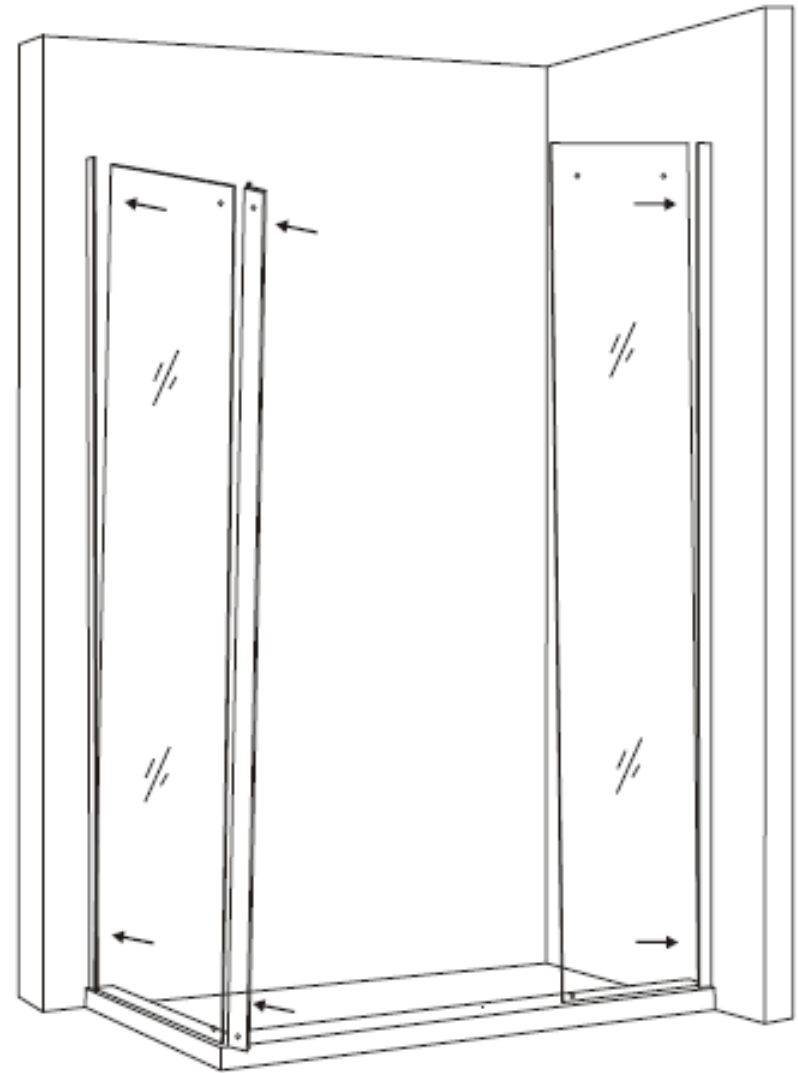

6



Procedimiento de Instalación

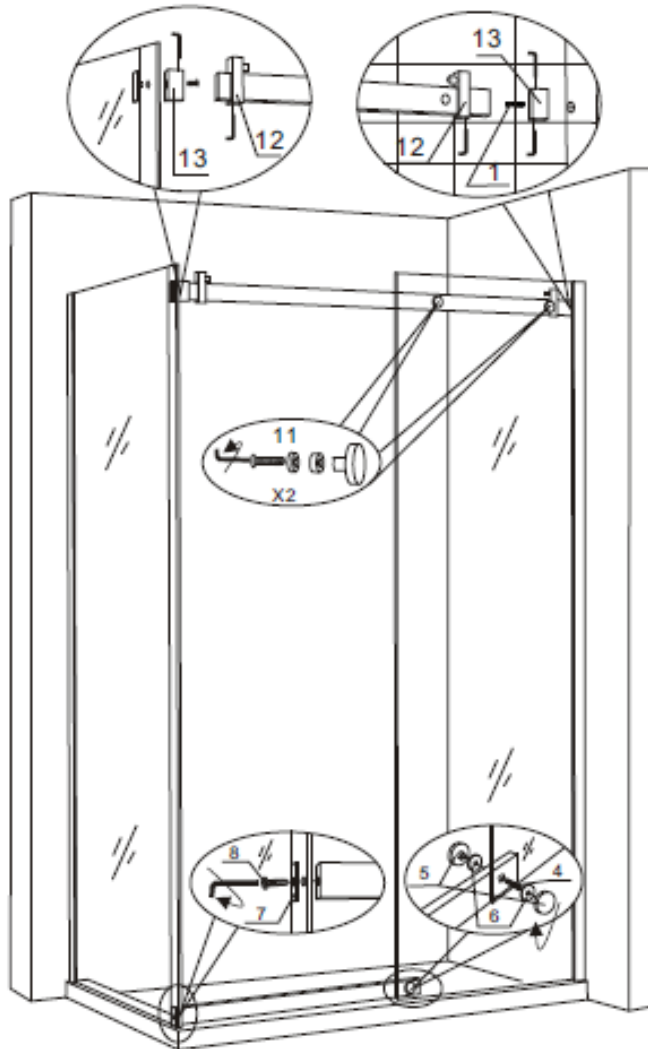

7

Procedimiento de instalación

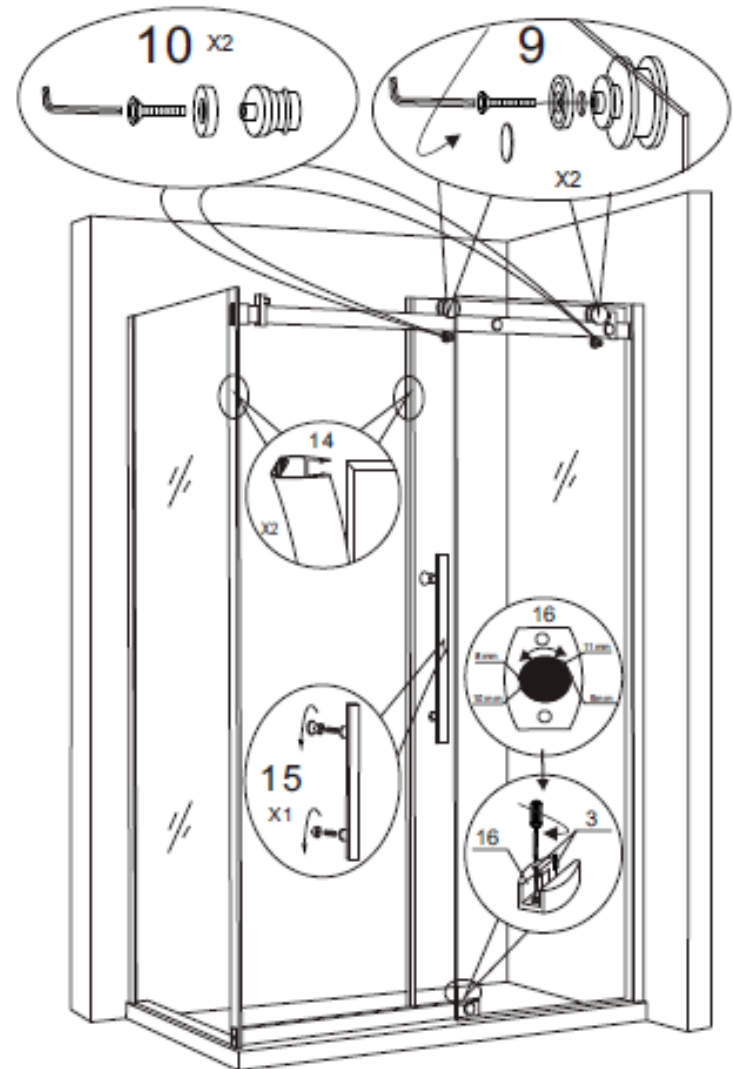

8



Procedimiento de Instalación

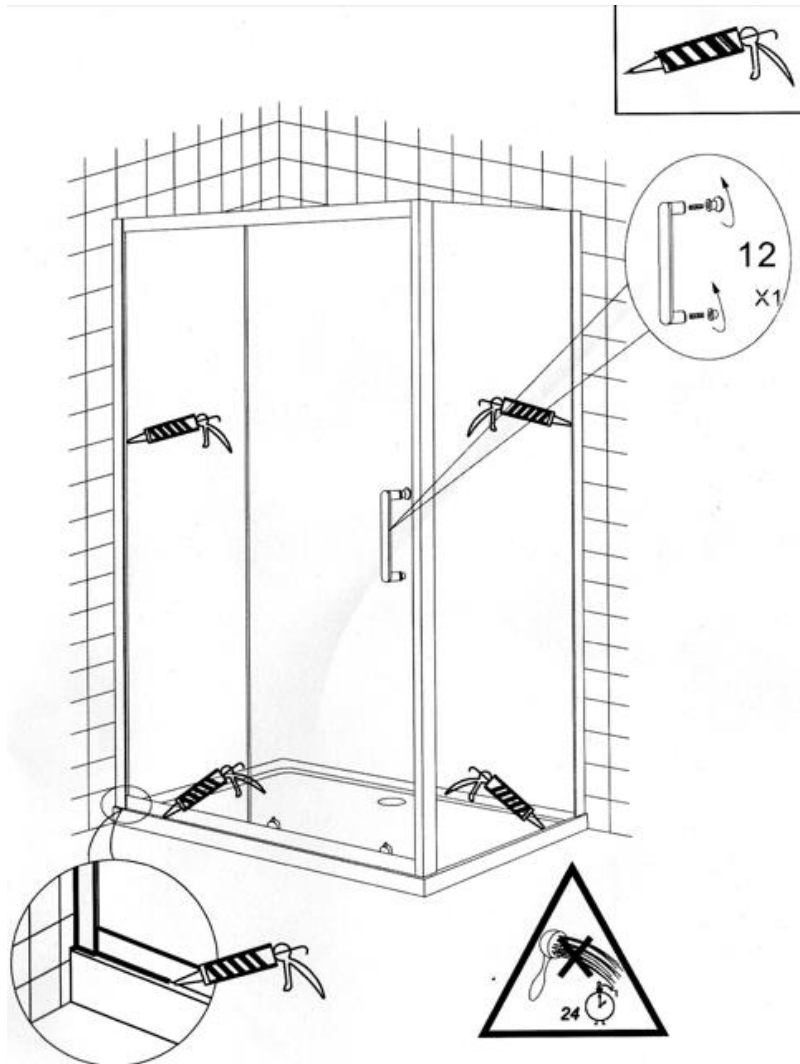

9

Procedimiento de instalación



10